

PCMflash module 31

Mitsubishi K-Line/Bootloader

Contents/Оглавление

Contents/Оглавление.....	2
KAWASAKI MH8115F.....	3
KIA/HYUNDAI (1999-2005) MH7203FA/MH8206F	4
HYUNDAI SONATA II (2000-2003) MH7202A+MH7202A	5
mitsubishi MH7201F/MH7202F/MH7203FA	6
MITSUBISHI CARISMA, LANCER EVO IX, PAJERO PININ MT (GDI) MH8201F	7
MITSUBISHI LANCER EVO V, EVO VI, EVO VII, EVO VIII, LANCER IX, PAJERO 2.5-3.2, TR4 MH8206F	8
MITSUBISHI CARISMA, LANCER 2.0 NA, OUTLANDER I, PAJERO 3.0-3.8L MH8302F.....	9
MITSUBISHI GRANDIS 2.4L, OUTLANDER 4G69 MIVEC 2003-2007, PAJERO V8(V9) 2007-2008 MH8304 ..	10
MITSUBISHI COLT (2003), ECLIPSE 3.8, GALANT MH8302F.....	11
MITSUBISHI COLT Z3X (2004-2011) MH8304F	12
MITSUBISHI ASX, LANCER X (EVO X), OUTLANDER 2.4-3.0 MH8104F/8106F/8115F	13
MAZDA 3/5/6/CX-7 Gen2 MH8106F/MH8110F.....	14
MAZDA TCM.....	15
SUBARU LEGACY (JDM) EJ204	16
SUZUKI GRAND VITARA MT 2004 MH7203F.....	17
SUZUKI MH8102F	18
SUZUKI MH8115F	19
SUZUKI GRAND VITARA MH8305F	20
SUZUKI BOAT MH8xxx.....	21

PCMflash

Engine Control Unit

MH8115F

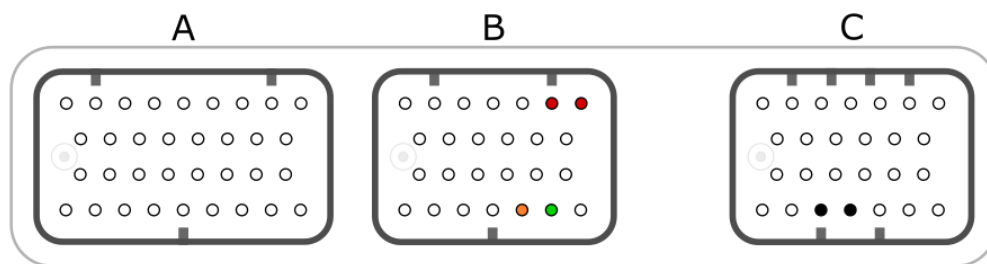

+12V	B: RED	GND	C: BLACK
Vpp	B: ORANGE	K-LINE	B: GREEN

KAWASAKI

pcmflash.ru

v.1

2024-01-23

PCMflash

Engine Control Unit

MH7203FA/MH8206F

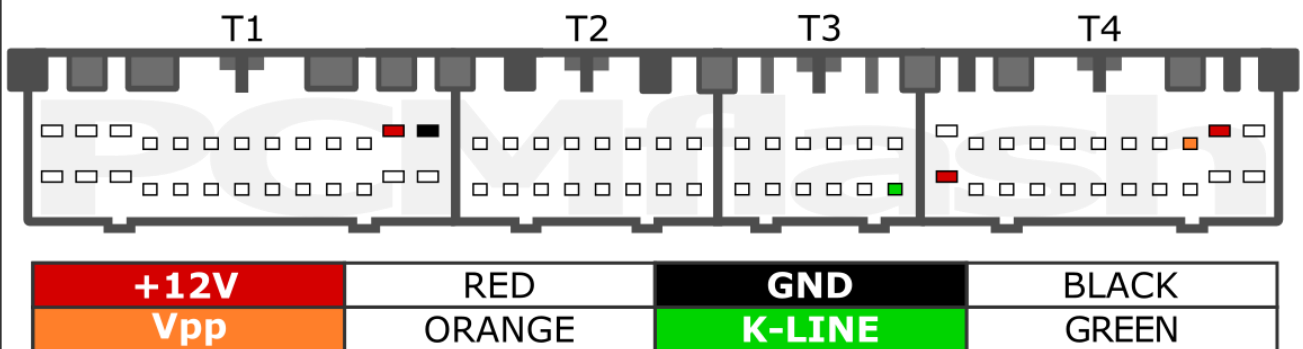

KIA/HYUNDAI (1999-2005)

pcmflash.ru

v.1

2022-01-14

PCMflash

Engine Control Unit + Transmission Control Unit
MH7202A + MH7202A

HYUNDAI SONATA II

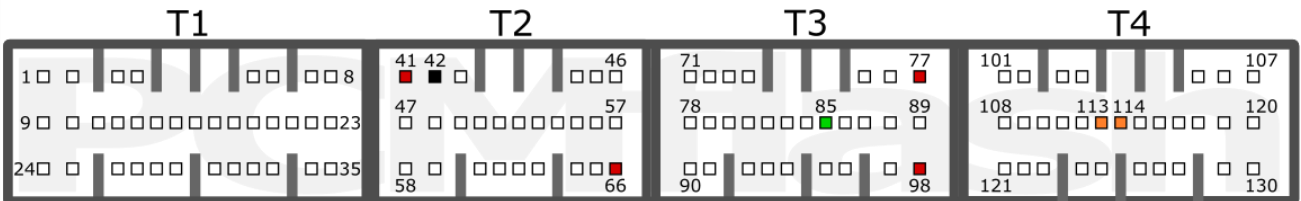

+12V	T2: 41, 66; T3: 77, 98	GND	T2: 42
Vpp	T4: 113, 114	K-LINE	T3: 85

HYUNDAI SONATA II (2000-2003)

pcmflash.ru

v.1

2022-01-14

PCMflash

Engine Control Unit

MH7201F/MH7202F/MH7203FA

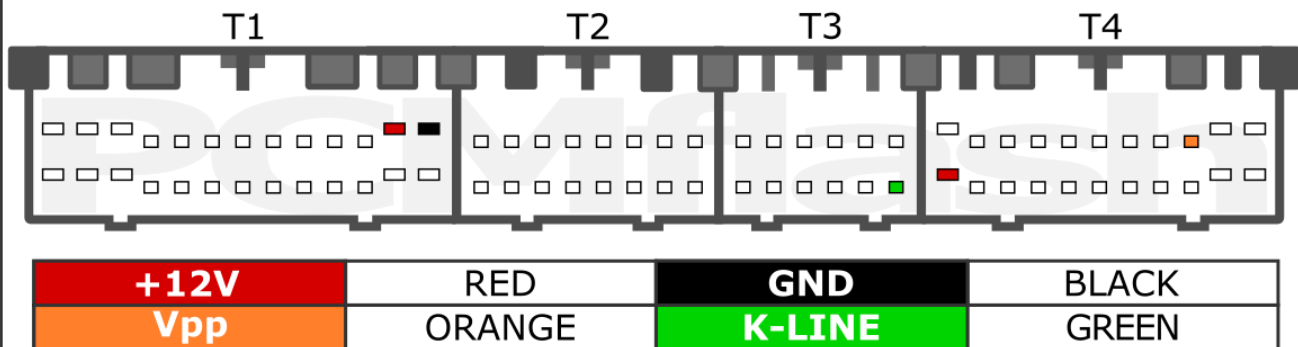

MITSUBISHI

pcmflash.ru

v.1

2023-02-18

PCMflash

Engine Control Unit

MH8201F

CARISMA, PAJERO PININ MT (GDI)

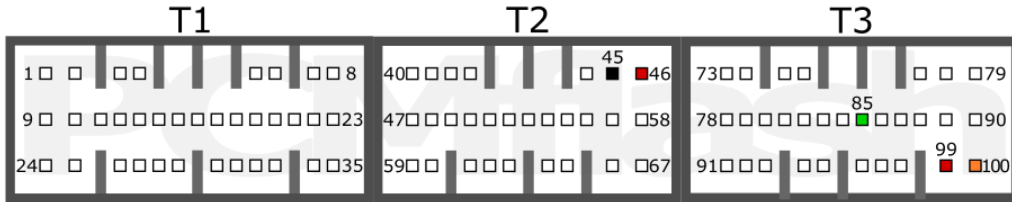

+12V	T2: 46; T3: 99	GND	T2: 45
Vpp	T3: 100	K-LINE	T3: 85

LANCER EVO IX

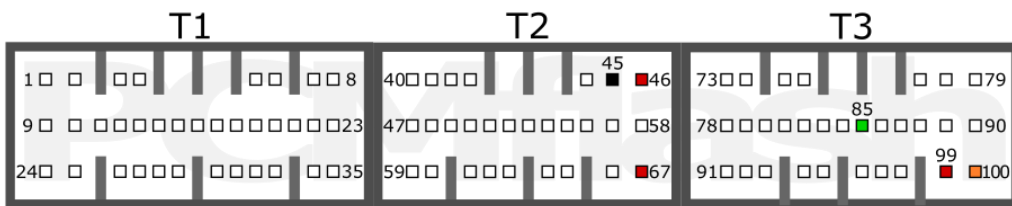

+12V	T2: 46, 67; T3: 99	GND	T2: 45
Vpp	T3: 100	K-LINE	T3: 85

CARISMA

LANCER EVO IX

PAJERO PININ MT (GDI)

pcmflash.ru

v.1

2021-12-26

PCMflash

Engine Control Unit

MH8206F

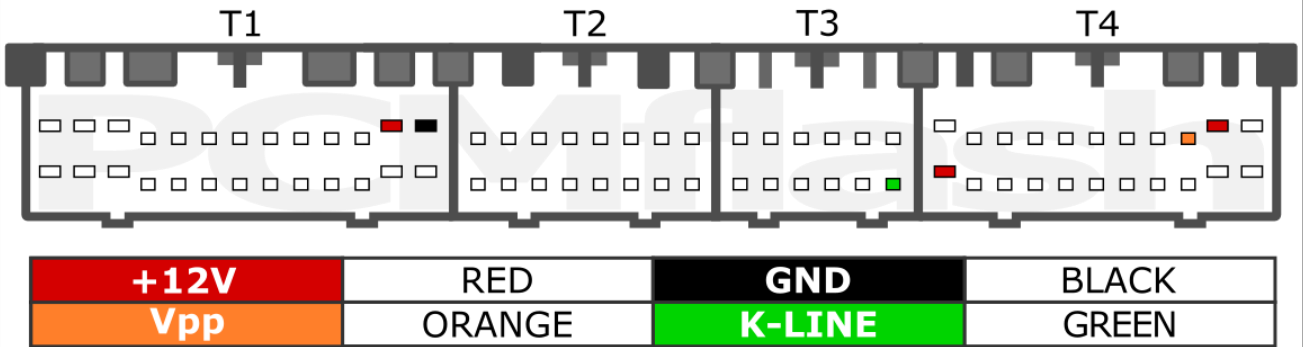

LANCER EVO V, EVO VI, EVO VII, EVO VIII, LANCER IX | PAJERO 2.5-3.2, TR4

pcmflash.ru

v.1

2021-12-26

PCMflash

Engine Control Unit

MH8302F

CARISMA, LANCER 2.0 NA, OUTLANDER I

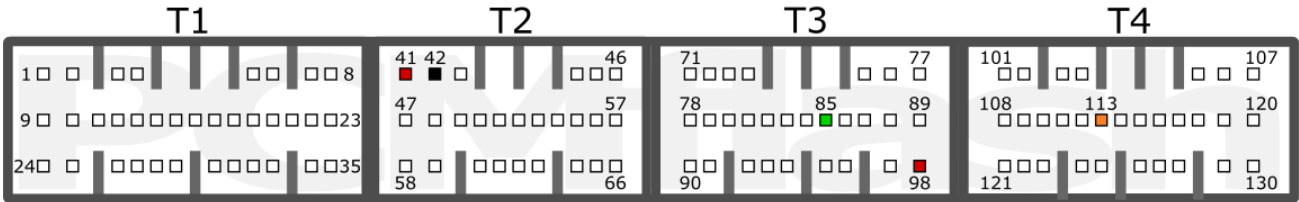

+12V	T2: 41; T3: 98	GND	T2: 42
Vpp	T4: 113	K-LINE	T3: 85

PAJERO 3.0-3.8L

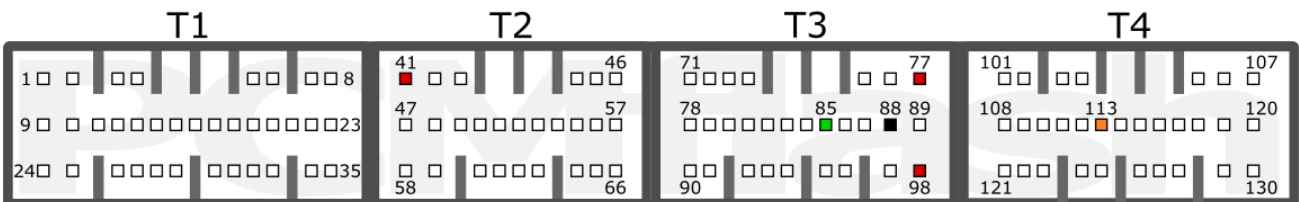

+12V	T2: 41; T3: 77, 98	GND	T3: 88
Vpp	T4: 113	K-LINE	T3: 85

CARISMA

LANCER 2.0 NA

OUTLANDER I

PAJERO 3.0-3.8L

pcmflash.ru

v.1

2022-01-18

PCMflash

Engine Control Unit

MH8304

OUTLANDER 4G69 MIVEC 2003-2007, PAJERO V8(V9) 2007-2008

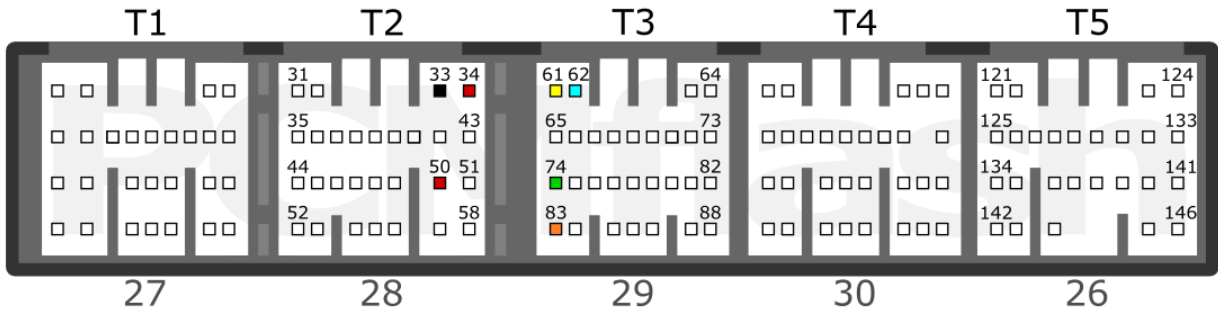

+12V	T2: 34, 50	GND	T2: 33
Vpp	T3: 83	K-LINE	T3: 74
CAN-L	T3: 62 (Not used)	CAN-H	T3: 61 (Not used)

GRANDIS 2.4L

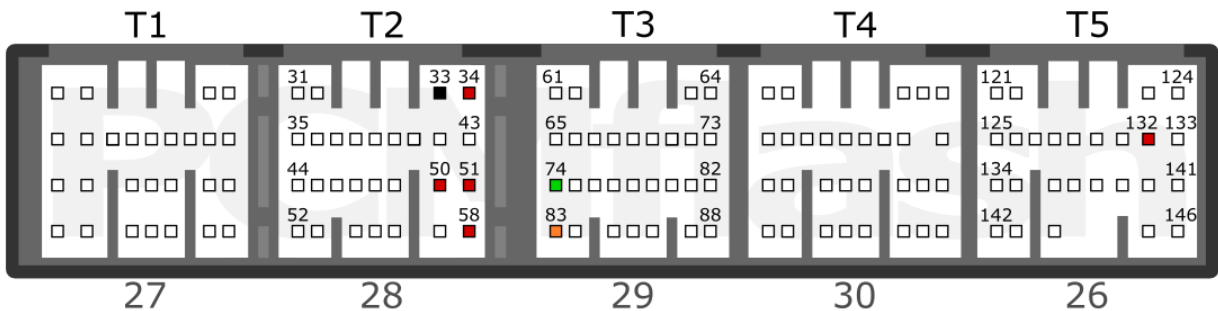

+12V	T2: 34, 50, 51, 58; T5: 132	GND	T2: 33
Vpp	T3: 83	K-LINE	T3: 74

GRANDIS 2.4L

OUTLANDER 4G69 MIVEC 2003-2007

PAJERO V8(V9) 2007-2008

pcmflash.ru

v.1

2022-01-18

PCMflash

Engine Control Unit

MH8302F

COLT (2003)

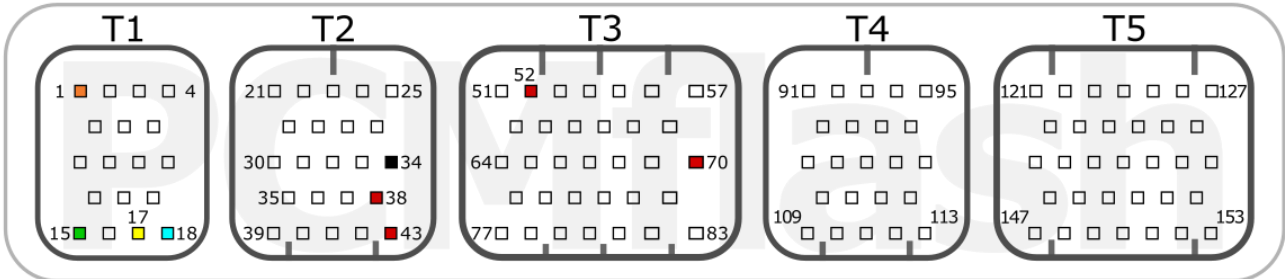

+12V	T2: 38, 43; T3: 52, 70	GND	T2: 34
Vpp	T1: 1	K-LINE	T1: 15
CAN-L	T1: 18 (Not used)	CAN-H	T1: 17 (Not used)

ECLIPSE 3.8

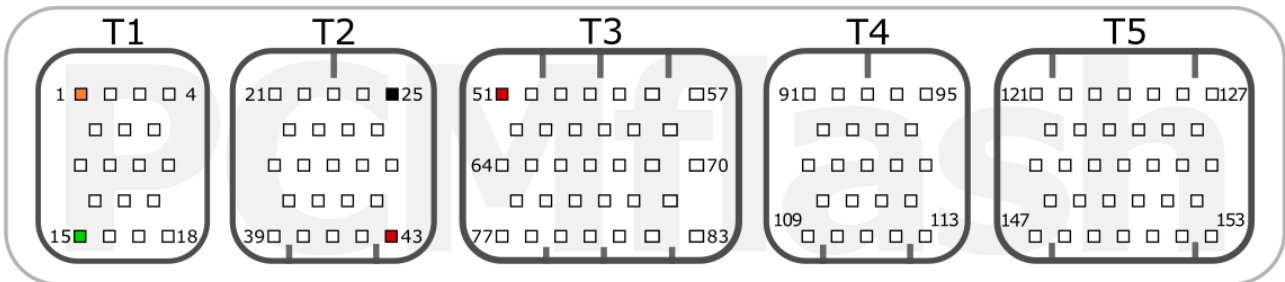

+12V	T2: 43; T3: 51	GND	T2: 25
Vpp	T2: 25	K-LINE	T1: 15

GALANT

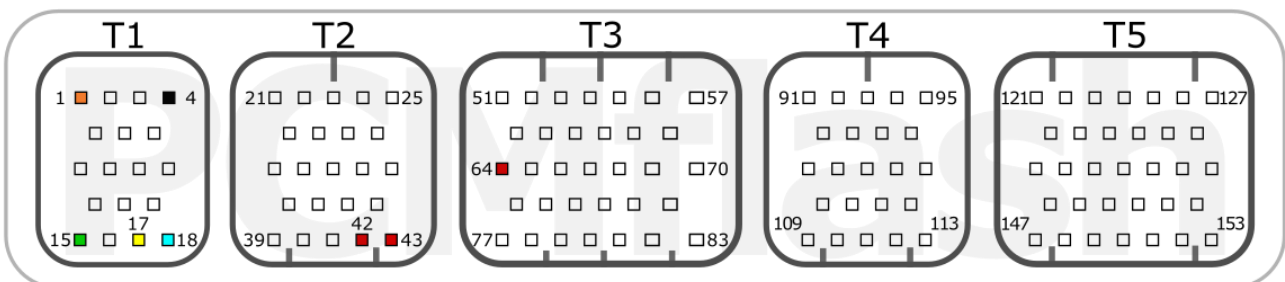

+12V	T2: 42, 43; T3: 64	GND	T1: 4
Vpp	T1: 1	K-LINE	T1: 15
CAN-L	T1: 18 (Not used)	CAN-H	T1: 17 (Not used)

COLT (2003)

ECLIPSE 3.8

GALANT

pcmflash.ru

v.1

2022-01-17

PCMflash

Engine Control Unit

MH8304F

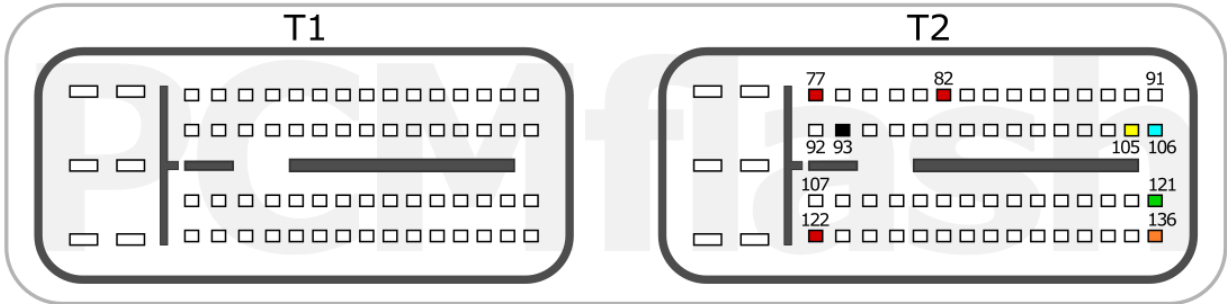

+12V	T2: 77, 82, 122	GND	T2: 93
Vpp	T2: 136	K-LINE	T2: 121
CAN-L	T2:106 (Not used)	CAN-H	T2:105 (Not used)

COLT Z3X (2004-2011)

pcmflash.ru

v.1

2021-12-26

PCMflash

Engine Control Unit

MH8104F/8106F/8115F

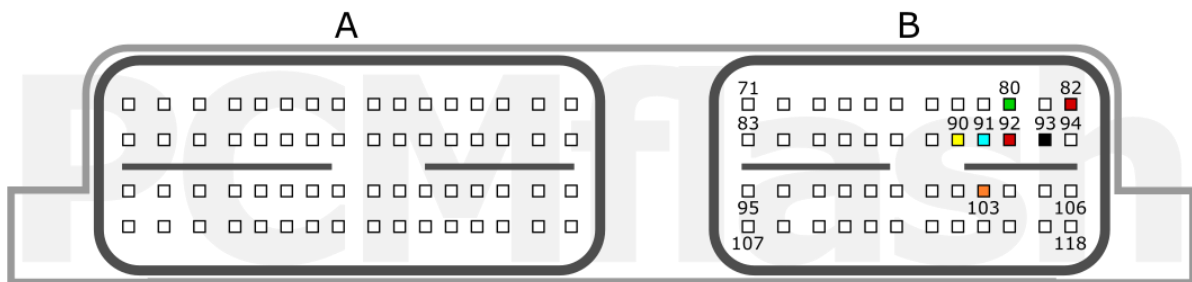

+12V	B: 82, 92	GND	B: 93
Vpp	B: 103	K-LINE	B: 80
CAN-L	B:91 (Not used)	CAN-H	B:90 (Not used)

ASX	LANCER X (EVO X)	OUTLANDER 2.4-3.0	
pcmflash.ru		v.1	2021-12-26

PCMflash

Engine Control Unit

MH8106F/MH8110F

Connection version 1

A

B

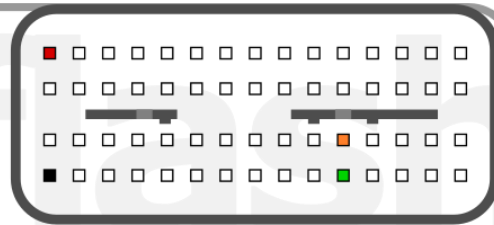
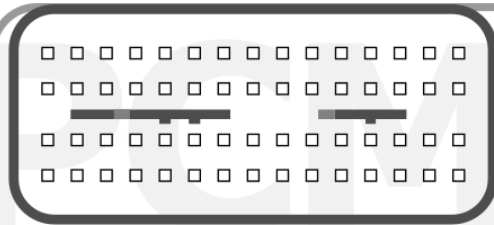

+12V	B: RED	GND	B: BLACK
Vpp	B: ORANGE	K-LINE	B: GREEN

Connection version 2

A

B

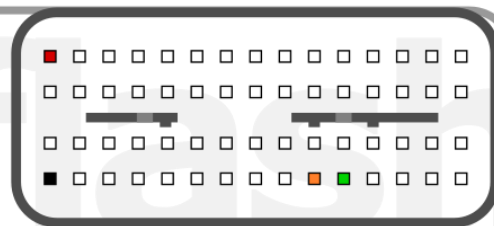
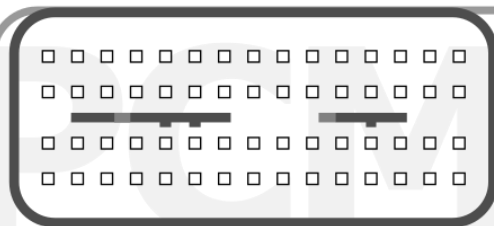

+12V	B: RED	GND	B: BLACK
Vpp	B: ORANGE	K-LINE	B: GREEN

Connection version 3

A

B

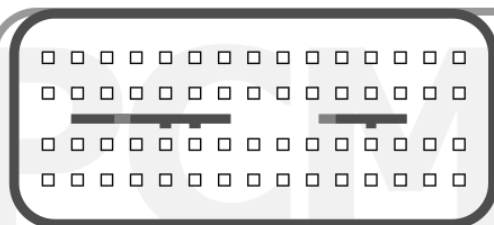

+12V	B: RED	GND	B: BLACK
Vpp	B: ORANGE	K-LINE	B: GREEN

MAZDA 3/5/6/CX-7 Gen2

pcmflash.ru

v.1

2022-04-04

PCMflash

Transmission Control Unit

Mazda TCM

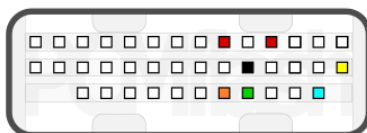

+12V	RED	GND	BLACK
Vpp	ORANGE	K-LINE	GREEN
CAN-L	CYAN (Not used)	CAN-H	YELLOW (Not used)

MAZDA

pcmflash.ru

v.1

2024-04-10

PCMflash

Engine Control Unit

EJ204

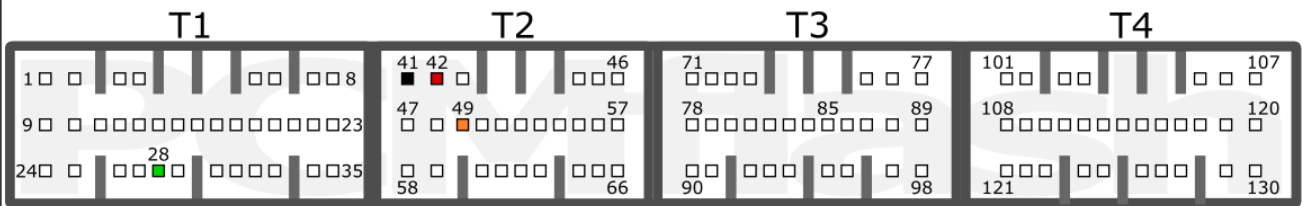

+12V	T2: 42	GND	T2: 41
Vpp	T2: 49	K-LINE	T1: 28

SUBARU LEGACY (JDM)

pcmflash.ru

v.1

2021-12-26

PCMflash

Engine Control Unit

MH7203F

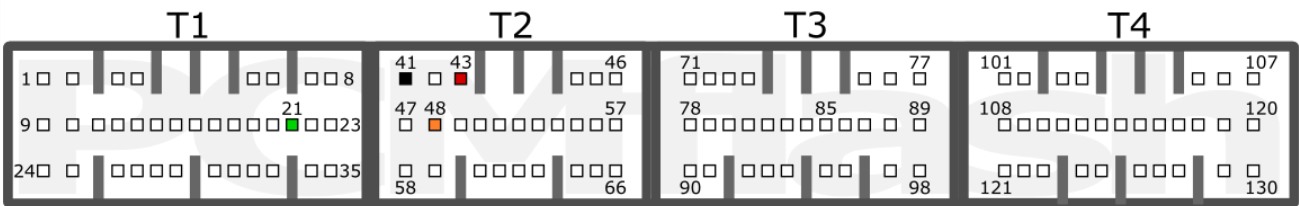

+12V	T2: 43	GND	T2: 41
Vpp	T2: 48	K-LINE	T1: 21

SUZUKI GRAND VITARA MT 2004

pcmflash.ru

v.1

2021-12-26

PCMflash

Engine Control Unit

MH8102F

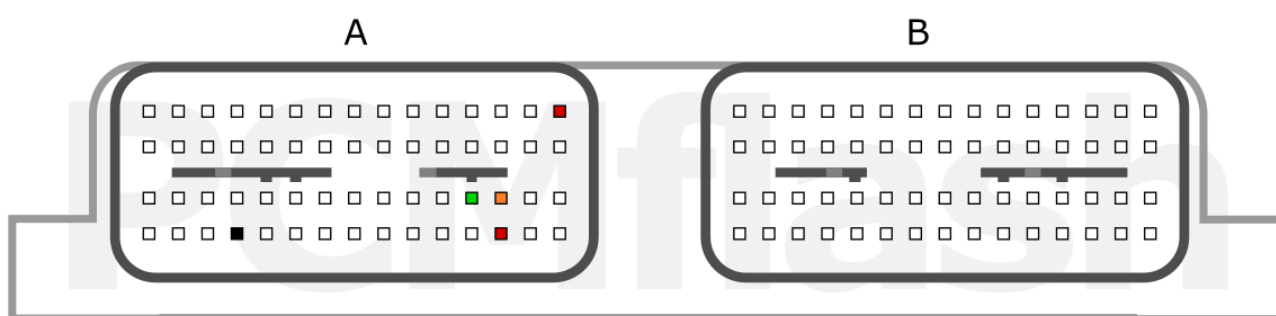

+12V	B: RED	GND	B: BLACK
Vpp	B: ORANGE	K-LINE	B: GREEN

SUZUKI

pcmflash.ru

v.1

2023-02-18

PCMflash

Engine Control Unit

MH8115F

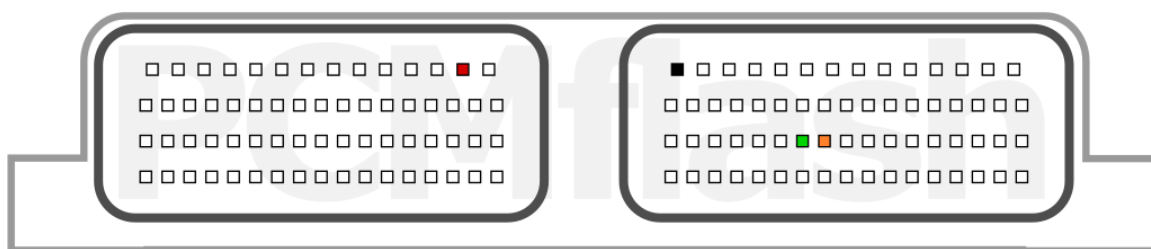

+12V	RED	GND	BLACK
Vpp	ORANGE	K-LINE	GREEN

SUZUKI

pcmflash.ru

v.1

2023-02-18

PCMflash

Engine Control Unit

MH8305F

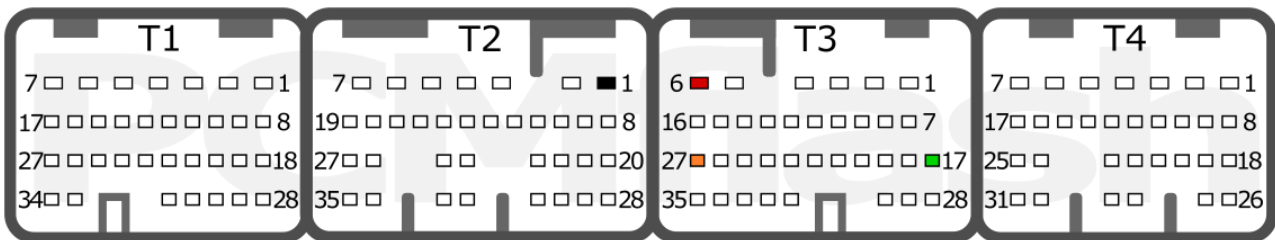

+12V	T3: 6	GND	T2: 1
Vpp	T3: 27	K-LINE	T3: 17

SUZUKI GRAND VITARA

pcmflash.ru

v.1

2021-12-26

PCMflash

Engine Control Unit

MH8xxx

TYPE 1

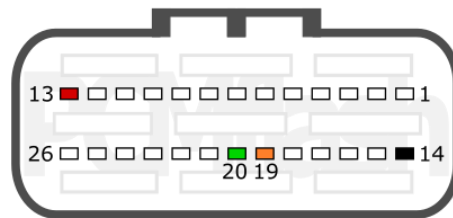

+12V	13	GND	14
Vpp	19	K-LINE	20

TYPE 2

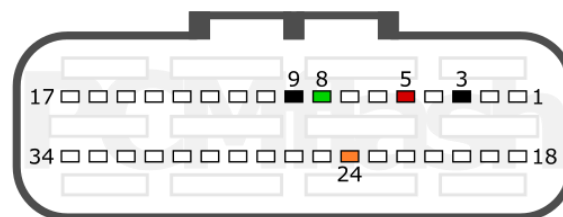

+12V	5	GND	3, 9
Vpp	24	K-LINE	8

TYPE 3

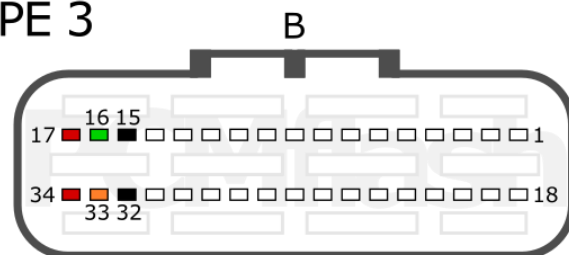
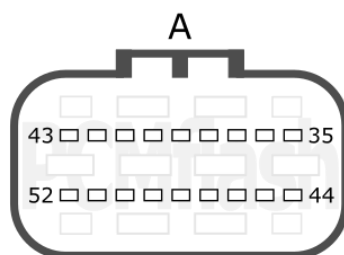

+12V	B: 17, 34	GND	B: 15, 32
Vpp	B: 33	K-LINE	B: 16

SUZUKI BOAT

pcmflash.ru

v.1

2023-02-20